



AUTOMOTIVE
OTOMOTİV
HYDRAULIC
HİDROLİK
PNEUMATIC
PNÖMATİK
MACHINE
MAKİNE
AGRICULTURAL
TARIM

MEYSELE
plastic protections

**2023
ÜRÜN
KATALOĞU**

PLASTİK

KORUYUCULAR
KUMANDA KOLLARI
KÖRÜKLER

www.meysele.com.tr





MEYSELE
plastic protections



MEYSELE HAKKINDA

MEYSELE PLASTİK 2008 YILINDA FALİYETE BAŞLAYAN VE KISA SÜREDE SEKTÖRDE YERİNİ ALMIŞ, YAPMIŞ OLDUĞU YATIRIMLARLA VE GELİŞTİRDİĞİ ÜRÜN ÇEŞİTLİLİĞİ İLE KISA SÜRE SONRA İHRACATA BAŞLAMISŞ SAYILI FİRMALAR ARASINDA YER ALMAYI BAŞARMIŞTIR.

MEYSELE , PLASTİK TAPA VE KORUYUCU İMALATININ YANI SIRA ÖZEL TAPA VE KORUYUCU ÜRÜNLER YAPIMAKTA, MÜŞTERİLERİNE BU KONU DA HIZLI ÇÖZÜMLER SUNMAKTADIR.

MEYSELE PLASTİK YAPISI, TEMELDE ENDÜSTRİYEL KALIP İMALATINDAN GELDİĞİ İÇİN BU KONUDAKİ TECRÜBELERİNİ PLASTİK TAPA VE KORUYUCU İMALATINDA ÇOK BAŞARALI BİR ŞEKİLDE KULLANMAYI BAŞARMIŞ, TEK ÇATI ALTINDA KALIP BÖLÜMÜ VE PLASTİK ENJEKSİYON BİRİMLERİNİ BULUNDURAN MEYSELE ,

KALİPLERİNİ SON TEKNOLOJİ CNC LERDE ÜRETMEKTE VE PLASTİK ÜRÜNLERİNİ İSE SON MODEL ENJEKSİYON MAKİNALARINDA ÜST KALİTE VE HIZLI ÜRETİM YAPMA BECERİSİNİ GÖSTERMİŞ, MÜŞTERİLERİNİN BUKONUDAKİ TAKDİRLERİNİ KAZANMAYI BAŞARMIŞTIR.

MEYSELE KALIP TECRÜBELİ KADROSU VE SON TEKNOLOJİ MAKİNALARI İLE KENDİSİNİ SÜREKLİ GELİŞTİRMEKTE VE YATIRIMLARINI HIZ KESMEDEN ARTIRMAKTADIR.





SCREW PLUGS

VIDALI TAPALAR

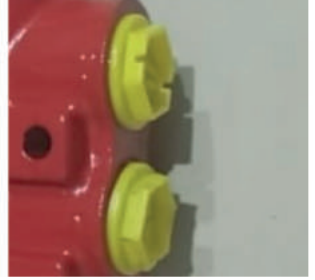

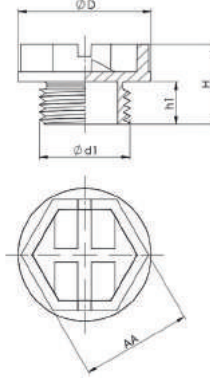

Malzeme / Material :POLIETİLEN/POLYTHENE

MEYSELE KOD / CODE	ÖLÇÜ (mm) / DIMENSIONI (mm)					
	GAZ / GAS	AA	D	d1	H	h1
100102	G 1/4 "	16,40	20,90	12,50	16,00	8,50
100103	G 3/8 "	15,80	21,30	16,15	16,00	8,50
100104	G 1/2 "	21,50	28,90	20,00	19,20	11,20
100106	G 3/4 "	24,40	32,30	25,80	17,70	10,50
100108	G 1 "	29,50	39,00	32,00	21,30	11,70
100110	G1 1/4 "	36,50	48,00	40,10	22,60	13,50
100112	G1 1/2 "	41,40	55,00	46,30	22,60	13,00

KOD / CODE	METRİK/METRIC	AA	D	d1	H	h1
100202	M12x1.5	15,80	21,30	11,50	15,70	8,50
100203	M14x1.5	15,80	21,30	13,50	15,70	8,50
100204	M16x1.5	15,80	21,30	15,50	15,70	8,50
100205	M18x1.5	21,50	28,90	18,20	19,20	10,90
100206	M20x1.5	21,50	28,90	19,40	19,20	11,20
100207	M22x1.5	21,50	28,90	21,80	18,00	10,20
100208	M24x1.5	21,50	28,90	25,50	18,00	10,20
100212	M39x4	36,50	48,00	38,00	30,00	22,00
100214	M45x2	41,40	54,80	43,40	22,70	13,00
100250	M10x1	15,80	21,30	9,60	14,50	7,20
100251	M12x1	15,80	21,30	11,70	14,50	7,20

KOD / CODE	UNF	AA	D	d1	H	h1
100151	3/4-16	21,50	28,90	12,60	19,00	11,00

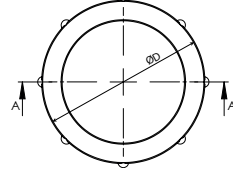
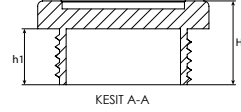
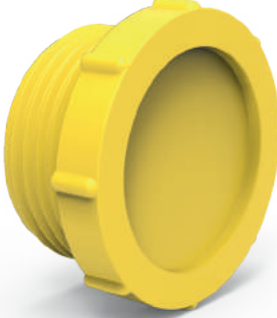

Malzeme / Material :POLİETİLEN/POLYTHENE

MEYSELE KOD / CODE	ÖLÇÜ (mm) / DIMENSIYONİ (mm)					
	GAZ / GAS	AA	D	d1	H	h1
100302	G 1/4 "	-	20,00	12,50	13,50	8,50
100303	G 3/8 "	-	20,00	16,00	13,50	8,50
100304	G 1/2 "	-	27,50	19,80	16,50	11,20
100306	G 3/4 "	-	31,30	25,50	15,30	10,50
100308	G 1 "	-	39,00	32,50	18,30	11,70
100310	G1 1/4 "	-	48,00	40,10	18,30	13,50
100312	G1 1/2 "	-	53,00	46,30	18,30	13,00
KOD / CODE	METRIK/METRIC	AA	D	d1	H	h1
100350	M12x1.5	-	20,00	11,50	13,50	8,50
100351	M14x1.5	-	20,00	13,50	13,50	8,50
100352	M16x1.5	-	20,00	15,50	13,50	8,50
100353	M18x1.5	-	27,20	18,20	17,00	10,90
100354	M20x1.5	-	28,90	19,40	17,00	11,20
100355	M22x1.5	-	28,90	21,80	16,00	10,20
100356	M24x1.5	-	28,90	25,50	18,00	10,20
100361	M39x4	-	48,00	38,00	30,00	22,00
100363	M45x2	-	58,00	43,40	19,00	13,00
100357	M10x1	-	20,00	9,60	12,50	7,20
100358	M12x1	-	20,00	11,70	12,50	7,20
KOD / CODE	UNF	AA	D	d1	H	h1
101201	3/4 - 16	-	27,00	18,90	17,00	11,00

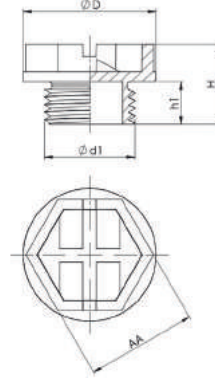

Malzeme / Material :POLIETILEN/POLYTHENE

MEYSELE KOD / CODE	GAZ / GAS	ÖLÇÜ (mm) / DIMENSIONİ (mm)				
		AA	D	d1	H	h1
100132	G 1/4 "	16,40	20,90	12,50	16,00	8,50
100133	G 3/8 "	15,80	21,30	16,15	16,00	8,50
100134	G 1/2 "	21,50	28,90	20,00	19,20	11,20
100136	G 3/4 "	24,40	32,30	25,80	17,70	10,50
100138	G 1 "	29,50	39,00	32,00	21,30	11,70
100140	G1 1/4 "	36,50	48,00	40,10	22,60	13,50
100142	G1 1/2 "	41,40	55,00	46,30	22,60	13,00

KOD / CODE	METRIK/METRIC	AA	D	d1	H	h1
100222	M12x1.5	15,80	21,30	11,50	15,70	8,50
100223	M14x1.5	15,80	21,30	13,50	15,70	8,50
100224	M16x1.5	15,80	21,30	15,50	15,70	8,50
100225	M18x1.5	21,50	28,90	18,20	19,20	10,90
100226	M20x1.5	21,50	28,90	19,40	19,20	11,20
100227	M22x1.5	21,50	28,90	21,80	18,00	10,20
100228	M24x1,5	21,50	28,90	25,50	18,00	10,20
100232	M39X4	36,50	48,00	38,00	30,00	22,00
100234	M45X2	41,40	54,80	43,40	22,70	13,00
100235	M10X1	15,80	21,30	9,60	14,50	7,20
100236	M12X1	15,80	21,30	11,70	14,50	7,20

KOD / CODE	UNF	AA	D	d1	H	h1
100241	3/4-16	21,50	28,90	18,90	19,00	11,00

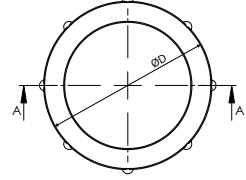
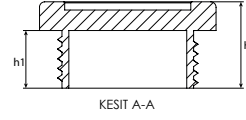

Malzeme / Material :POLİETİLEN/POLYTHENE

MEYSELE KOD / CODE	ÖLÇÜ (mm) / DIMENSIONI (mm)					
	GAZ / GAS	AA	D	d1	H	h1
100322	G 1/4 "	-	20,00	12,50	13,50	8,50
100323	G 3/8 "	-	20,00	16,00	13,50	8,50
100324	G 1/2 "	-	27,50	19,80	16,50	11,20
100326	G 3/4 "	-	31,30	25,50	15,30	10,50
100328	G 1 "	-	39,00	32,50	18,30	11,70
100330	G1 1/4 "	-	48,00	40,10	18,30	13,50
100332	G1 1/2 "	-	53,00	46,30	18,30	13,00
KOD / CODE	METRIK/METRIC	AA	D	d1	H	h1
100370	M12x1.5	-	20,00	11,50	13,50	8,50
100371	M14x1.5	-	20,00	13,50	13,50	8,50
100372	M16x1.5	-	20,00	15,50	13,50	8,50
100373	M18x1.5	-	27,20	18,20	17,00	10,90
100374	M20x1.5	-	28,90	19,40	17,00	11,20
100375	M22x1.5	-	28,90	21,80	16,00	10,20
100376	M24x1.5	-	28,90	25,50	18,00	10,20
100377	M39x4	-	48,00	38,00	30,00	22,00
100378	M45x2	-	58,00	43,40	19,00	13,00
100379	M10x1	-	20,00	9,60	12,50	7,20
100380	M12x1	-	20,00	11,70	12,50	7,20
KOD / CODE	UNF	AA	D	d1	H	h1
100391	3/4 - 16	-	27,00	18,90	17,00	11,00

SCREW PLUGS
PARÇA VİDALI TAPA

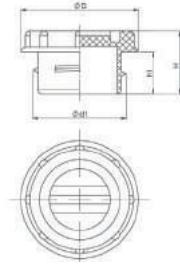

PLASTIC PLUG
PLASTİK TAPA

Malzeme / Material : POLİETİLEN/POLYTHENE

MEYSELE KOD / CODE	ÖLÇÜ (mm) / DIMENSIYONİ (mm)					
	GAZ / GAS	AA	D	d1	H	h1
100402	G 1/4 "	-	18,60	12,90	14,20	9,30
100403	G 3/8 "	-	21,20	15,90	14,80	9,80
100404	G 1/2 "	-	26,50	20,00	15,80	9,80
100405	G 5/8 "	-	26,50	22,50	17,50	11,50
100406	G 3/4 "	-	31,70	26,00	17,00	10,80
100408	G 1 "	-	39,00	31,80	16,30	11,30
100410	G1 1/4 "	-	49,00	40,70	17,30	12,30
100412	G1 1/2 "	-	53,00	47,70	19,00	13,50

SCREW PLUGS
ANAHTAR BAŞLI PARÇA VİDALI TAPA

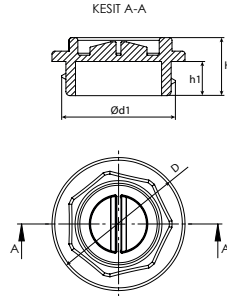

Malzeme / Material : POLİETİLEN/POLYTHENE

MEYSELE KOD / CODE	ÖLÇÜ (mm) / DIMENSIYONİ (mm)					
	GAZ / GAS	AA	D	d1	H	h1
100508	G 1 "	-	39,20	32,20	20,00	11,50
100510	G1 1/4 "	-	48,50	41,00	21,00	12,00
100512	G1 1/2 "	-	53,60	47,40	22,50	14,00

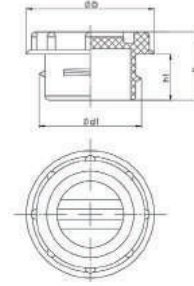

Malzeme / Material :POLIETİLEN/POLYTHENE

MEYSELE KOD / CODE	METRİK/METRIC	AA	ÖLÇÜ (mm) / DIMENSIONI (mm)			
			D	d1	H	h1
100500	M14	-	24,00	M14	17,50	7,50
100501	M16	-	24,00	M16	17,50	7,50

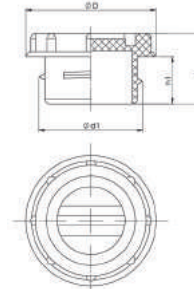

Malzeme / Material :POLIETİLEN/POLYTHENE

MEYSELE KOD / CODE	METRİK/METRIC	AA	ÖLÇÜ (mm) / DIMENSIONI (mm)			
			D	d1	H	h1
100451	M14	-	24,00	M14	17,50	7,50
100452	M16	-	24,00	M16	17,50	7,50

SLOTTED - THREADED PLUG YARIKLI TAPA

MEYSELE
plastic protections

PLASTIC PLUG
PLASTIK TAPA

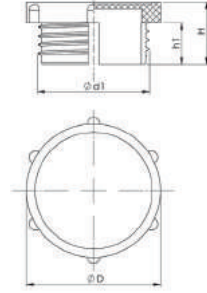

Malzeme / Material : POLIETILEN / POLYTHENE

MEYSELE KOD / CODE	METRİK/METRIC	AA	ÖLÇÜ (mm) / DIMENSIONI (mm)			
			D	d1	H	h1
100805	M18x1,5	-	24,20	17,50	15,00	10,00

SCREW PLUGS MAŞON TAPASI

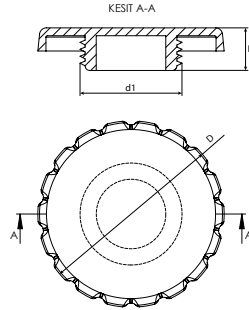

Malzeme / Material : POLIETILEN / POLYTHENE

MEYSELE KOD / CODE	METRİK/METRIC	MODEL	ÖLÇÜ (mm) / DIMENSIONI (mm)			
			D	d1	L	H
103201	M22x1,5	PARÇA VIDALI	40,00	21,80	-	9,50
103202	M22x1,5	VIDALI	40,00	21,80	-	9,50

IN-HOLE PLUGS DELİK İÇİ TAPALAR



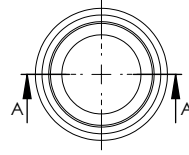
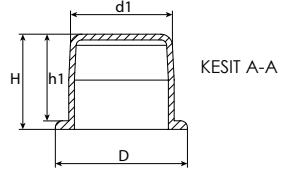
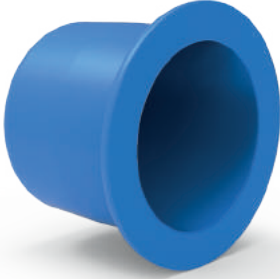

Malzeme / Material :PVC

MEYSELE KOD / CODE	ÖLÇÜ (mm) / DIMENSIONI (mm)					
	GAZ / GAS	AA	D	d1	H	h1
100901	G 1/8 "	-	11,80	8,90	6,00	5,00
100902	G 1/4 "	-	14,00	11,90	10,50	9,00
100903	G 3/8 "	-	18,50	15,40	10,20	9,00
100904	G 1/2 "	-	22,00	19,10	13,80	12,00
100906	G 3/4 "	-	28,00	24,80	13,80	13,00
100908	G 1 "	-	36,50	30,70	16,00	14,00
100910	G1 1/4 "	-	48,00	39,70	16,00	14,00
100912	G1 1/2 "	-	52,00	45,50	17,00	15,00
KOD / CODE	METRİK/METRIC	AA	D	d1	H	h1
101001	M10x1,5	-	11,80	8,70	4,50	5,70
KOD / CODE	MM	AA	D	d1	H	h1
103306	9,00	-	15,80	9,00	9,00	7,00
103305	13,50	-	16,00	13,50	10,40	9,40
103301	15,40	-	19,20	15,40	12,50	11,50
103304	17,50	-	20,00	17,50	15,50	14,50
103307	19,00	-	22,00	19,00	12,30	11,50
103302	21,50	-	26,00	21,50	17,00	15,50
103303	27,70	-	32,50	27,70	19,30	18,00
103304	33,10	-	38,80	33,10	10,50	8,50

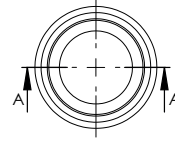
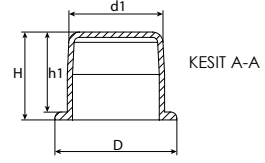

Malzeme / Material : POLİETİLEN/POLYTHENE

MEYSELE KOD / CODE	ÖLÇÜ (mm) / DIMENSIYONİ (mm)					
	GAZ / GAS	AA	D	d1	H	h1
101103	G 3/8 "	-	18,50	15,40	10,20	9,00
101104	G 1/2 "	-	22,50	19,10	13,80	12,00
101106	G 3/4 "	-	28,00	24,80	13,80	13,00
101108	G 1 "	-	36,50	30,70	16,00	14,00
101110	G1 1/4 "	-	48,00	39,70	16,00	14,00
101112	G1 1/2 "	-	52,00	45,50	17,00	15,00
KOD / CODE	MM	AA	D	d1	H	h1
101301	12,20	-	15,80	12,20	11,00	10,00
101302	15,40	-	19,20	15,40	12,30	11,50
101303	17,90	-	23,20	17,90	12,00	10,00
101304	20,00	-	24,00	20,00	16,50	14,50
101305	20,20	-	29,00	20,20	14,00	12,00
101307	21,50	-	25,00	21,50	15,20	14,00
101308	24,30	-	26,00	24,30	11,50	10,00
101309	26,80	-	33,50	26,80	23,00	21,00
101310	27,70	-	32,50	27,70	20,40	19,60
101311	30,50	-	36,50	30,50	16,00	14,00
101312	33,10	-	38,80	33,10	10,50	8,50
101313	34,40	-	38,50	34,40	22,20	20,00
101314	22,00	-	24,50	22,00	15,00	14,00
101315	9,00	-	15,80	9,00	9,00	7,00

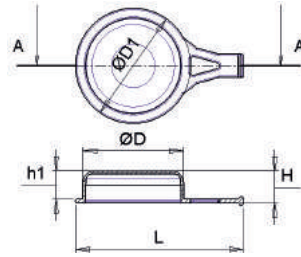

Malzeme / Material : POLİETİLEN / POLYTHENE

MEYSELE KOD / CODE	METRİK/METRIC	ÖLÇÜ (mm) / DIMENSIYONİ (mm)				
		L	D	d1	H	h1
102551	M28	50,00	31,00	26,50	11,00	10,00
102552	M36	58,00	40,00	34,50	11,00	10,00

MEYSELE KOD / CODE	MM	ÖLÇÜ (mm) / DIMENSIYONİ (mm)				
		L	D	d1	H	h1
102501	18,90	30,00	24,00	18,90	12,00	10,50
102502	27,80	38,00	34,00	27,80	13,00	11,50

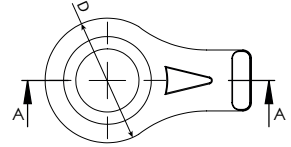
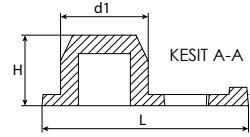

Malzeme / Material :PVC

MEYSELE KOD / CODE	ÖLÇÜ (mm) / DIMENSIONI (mm)					
	GAZ / GAS	AA	D	d1	L	H
102201	G 1/8 "	-	17,00	9,50	27,00	8,50
102202	G 1/4 "	-	16,00	11,80	27,00	9,50
KOD / CODE	METRİK/METRIC	AA	D	d1	L	H
102301	M10x1,5	-	17,00	9,00	27,00	8,50
KOD / CODE	MM	AA	D	d1	L	H
102401	4,00	-	9,00	4,00	11,00	6,50
102402	9,90	-	17,00	9,90	27,00	8,50

BARREL PLUGS BOMBELİ TAPA

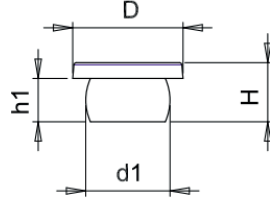

PLASTIC PLUG
PLASTİK TAPA

Malzeme / Material : POLIETİLEN/POLYTHENE

MEYSELE KOD / CODE	ÖLÇÜ (mm) / DIMENSIONI (mm)					
	MM	AA	D	d1	H	h1
101850	11,00	-	13,90	11,00	7,80	5,60

ROUND TUBE PLUGS KANALLI KÖR TAPA

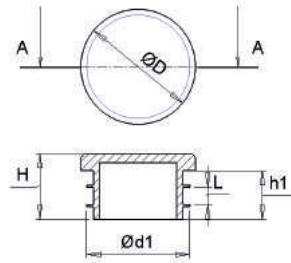
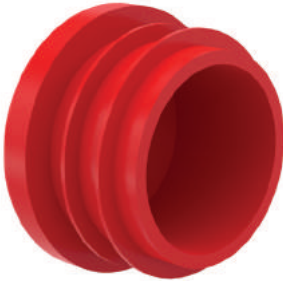

Malzeme / Material : POLIETİLEN/POLYTHENE

MEYSELE KOD / CODE	ÖLÇÜ (mm) / DIMENSIONI (mm)					
	MM	D	d1	L	H	h1
102748	10,00	16,00	10,00	2,00	9,00	7,50
102749	10,00	11,00	10,00	2,00	9,00	7,50
102750	16,00	22,00	15,70	3,00	14,50	13,00
102751	18,00	20,00	18,00	2,70	11,00	8,00
102752	20,00	21,50	20,00	1,70	13,50	10,50
102753	25,00	26,00	25,00	1,80	13,50	9,50

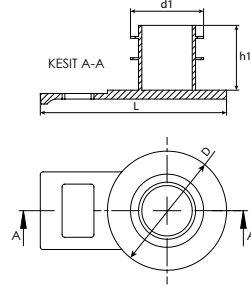

Malzeme / Material :POLİETİLEN/POLYTHENE

MEYSELE KOD / CODE	ÖLÇÜ (mm) / DIMENSIONI (mm)					
	GAZ / GAS	AA	D	d1	L	H
102802	G 1/4 "		22,00	13,00	33,00	12,00
KOD / CODE	METRİK/METRIC	AA	D	d1	L	H
102903	M14x1,5	-	22,00	13,00	33,00	12,00
102904	M16x1,5	-	22,00	15,70	33,00	13,00
102907	M22x1,5	-	27,40	21,40	39,00	13,00

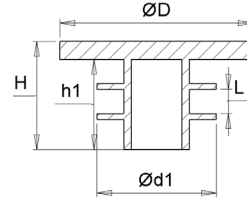

Malzeme / Material :POLİETİLEN/POLYTHENE

MEYSELE KOD / CODE	ÖLÇÜ (mm) / DIMENSIONI (mm)					
	GAZ / GAS	D	d1	L	H	h1
102851	G 1/4 "	22,00	13,00	2,00	10,00	9,00
KOD / CODE	METRİK/METRIC	D	d1	L	H	h1
102951	M14x1,5	22,00	13,00	3,00	14,50	13,00
102952	M16x1,5	22,00	15,70	3,00	14,50	13,00

PULL PLUGS
DIK SAPLI KANALLI TAPA

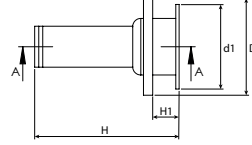
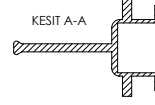

PLASTIC PLUG
PLASTİK TAPA

Malzeme / Material :POLİETİLEN/POLYTHENE

MEYSELE KOD / CODE	METRİK/METRIC	ÖLÇÜ (mm) / DIMENSIONI (mm)				
		AA	D	d1	H	h1
102703	M12x1,5	-	13,70	11,70	26,50	4,00
102704	M14x1,5	-	15,80	13,40	26,50	4,00
102701	M16x1,5	-	18,00	15,70	26,50	4,00
102702	M18x1,5	-	22,00	17,80	26,50	4,00

BLIND PLUG
KÖR TAPA

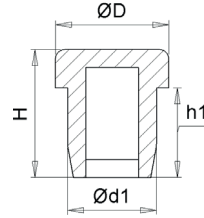

Malzeme / Material :POLİETİLEN/POLYTHENE

MEYSELE KOD / CODE	METRİK/METRIC	ÖLÇÜ (mm) / DIMENSIONI (mm)				
		AA	D	d1	H	h1
101871	M8	-	9,00	6,90	10,00	7,00
KOD / CODE	MM	AA	D	d1	H	h1
101861	4,50	-	6,50	4,50	6,00	5,20
101862	5,50	-	11,00	5,50	9,00	7,50

PROTECTIVE CAPS

DIŞ ÜSTÜ KAPAKLAR

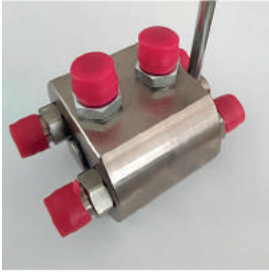

MEYSELE
plastic protections

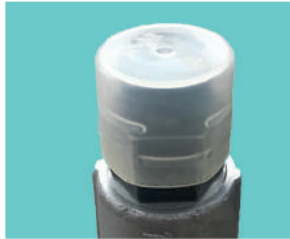

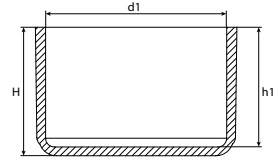

KESİT A-A

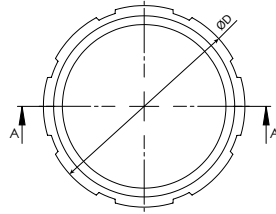

Malzeme / Material :PVC

MEYSELE KOD / CODE	ÖLÇÜ (mm) / DIMENSIYONİ (mm)					
	GAZ / GAS	AA	D	d1	H	h1
101403	G 3/8 "	-	19,00	16,50	21,00	20,00
101404	G 1/2 "	-	23,00	20,50	21,00	20,00
101408	G 1 "	-	36,00	32,00	22,00	20,00
KOD / CODE	METRİK/METRIC	AA	D	d1	H	h1
101503	M14x1,5	-	16,70	13,70	22,00	21,00
101504	M22x1,5	-	23,00	20,50	21,00	20,00
KOD / CODE	MM	AA	D	d1	H	h1
101601	31,00	-	34,00	31,00	22,00	20,00
101602	37,50	-	39,00	36,00	22,00	20,00

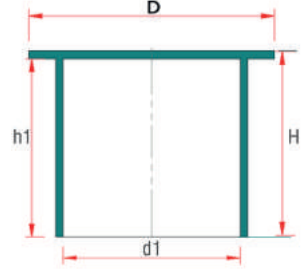

Malzeme / Material : POLIETİLEN/POLYTHENE

MEYSELE KOD / CODE	ÖLÇÜ (mm) / DIMENSIONI (mm)					
	METRİK/METRIC	AA	D	d1	H	h1
101921	M6	-	14,00	5,80	30,00	29,00
KOD / CODE	MM	AA	D	d1	H	h1
101903	6,50	-	14,00	6,50	30,00	29,00
101902	7,60	-	13,50	7,60	16,00	15,00
101904	8,00	-	14,00	7,80	30,00	29,00
101905	8,00	-	15,00	7,80	74,00	73,00
101901	9,00	-	15,00	9,00	16,00	15,00
101906	22,00	-	29,00	22,00	35,00	32,00
101907	26,00	-	33,00	26,00	45,00	42,00
101908	30,00	-	39,50	30,00	60,00	57,00

FLAT CAPS DIŐ ÜSTÜ KAPAK

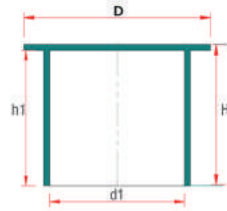

PLASTIC PLUG
PLASTIK TAPA

Malzeme / Material : POLIETILEN / POLYTHENE

MEYSELE KOD / CODE	ÖLÇÜ (mm) / DIMENSIONI (mm)					
	MM	AA	D	d	H	h1
101801	24,00	-	26,50	24,00	23,50	21,00
101802	26,50	-	32,50	26,50	23,50	22,00
101803	32,00	-	35,50	32,00	23,50	22,00
101804	40,00	-	44,00	40,00	30,50	29,00
101805	21,80	-	24,50	21,80	20,00	18,00
101806	48,50	-	57,00	48,50	12,00	10,00
101807	54,50	-	60,00	54,50	23,00	21,00

HEX CAPS ALTIGEN KAPAK

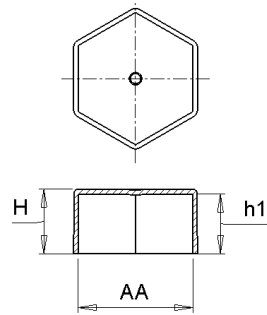

Malzeme / Material : POLIETILEN / POLYTHENE

MEYSELE KOD / CODE	ÖLÇÜ (mm) / DIMENSIONI (mm)					
	WHITWORTH	AA	D	d1	H	h1
101500	-	31,50x31,50	-	-	17,80	16,00

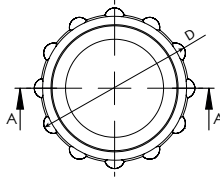
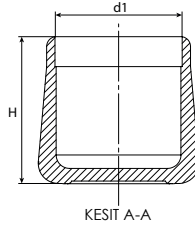

Malzeme / Material :PVC

MEYSELE KOD / CODE	WHITWORTH	ÖLÇÜ (mm) / DIMENSIONI (mm)				
		AA	D	d1	H	h1
102012	W9/16	-	18,70	13,50	20,00	18,50
102013	W5/8	-	21,50	15,50	23,50	22,00
102014	W3/4	-	23,80	18,30	21,80	20,00

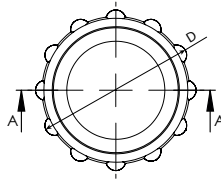
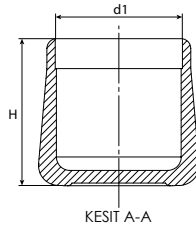

Malzeme / Material : POLETİLEN / POLYTHENE

MEYSELE KOD / CODE	WHITWORTH	AA	ÖLÇÜ (mm) / DIMENSIYONİ (mm)			
			D	d1	H	h1
102112	W9/16	-	18,70	13,50	20,00	18,50
102113	W5/8	-	21,50	15,50	23,50	22,00
102114	W3/4	-	23,80	18,30	21,80	20,00

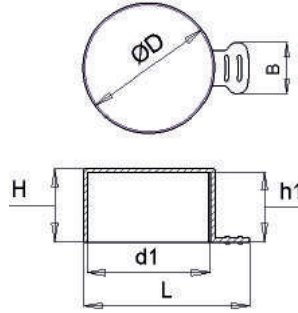

Malzeme / Material : POLİETİLEN/POLYTHENE

MEYSELE KOD / CODE	ÖLÇÜ (mm) / DIMENSIYONİ (mm)						
	GAZ / GAS	L	D	d1	H	h1	B
101951	G1/4	21,80	14,60	13,30	13,00	12,00	12,00
101952	G3/8	27,40	18,40	16,80	13,00	12,00	14,00
101955	G3/4	38,20	28,40	26,40	16,80	15,80	14,00
101957	G1	45,00	35,50	33,25	21,00	19,00	14,00

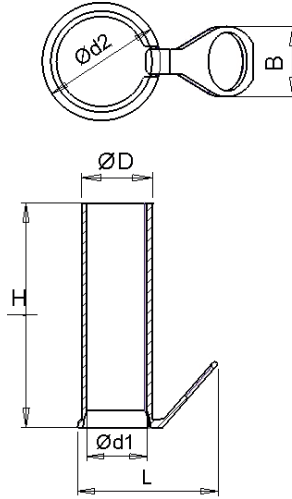
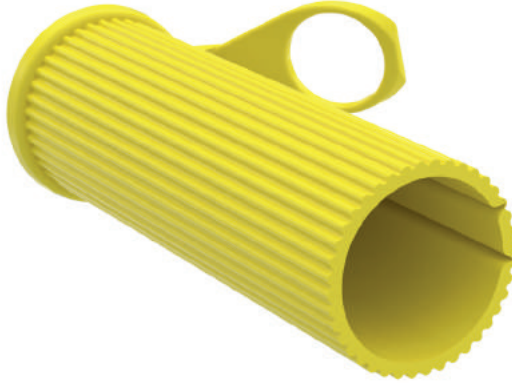

Malzeme / Material : POLETILEN/POLYTHENE

MEYSELE KOD / CODE	ÖLÇÜ (mm) / DIMENSIONI (mm)						
	MM	L	D	d1	d2	H	B
101970	32	74,50	37,80	32,00	42,00	120,00	25,00

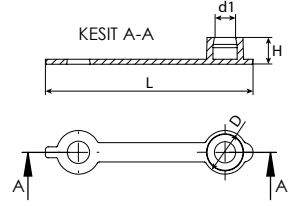

Malzeme / Material : POLIETİLEN/POLYTHENE

MEYSELE KOD / CODE	METRİK/METRIC	AA	ÖLÇÜ (mm) / DIMENSIONI (mm)			
			D	d1	L	H
150401	M6	-	11,50	M6	55,00	8,00

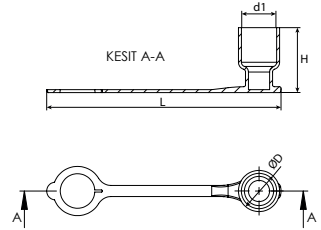

Malzeme / Material : POLIETİLEN/POLYTHENE

MEYSELE KOD / CODE	MM	d2	ÖLÇÜ (mm) / DIMENSIONI (mm)			
			D	d1	L	H
150301	ERKEK	23,00	28,00	24,00	160,00	43,00

PLUGS
GLASÖRLÜK TAPASI

MEYSELE
plastic protections

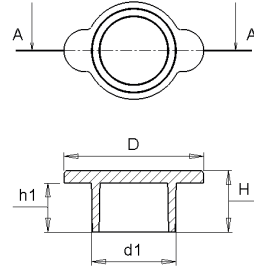

PLASTIC PLUG
PLASTIK TAPA

Malzeme / Material :POLIETILEN/POLYTHENE

MEYSELE KOD / CODE	METRİK/METRIC	AA	ÖLÇÜ (mm) / DIMENSIYONİ (mm)			
			D	d1	H	h1
150410	M6	-	16,50	9,80	8,00	5,80

NUT COVER
SOMUN KAPAĞI

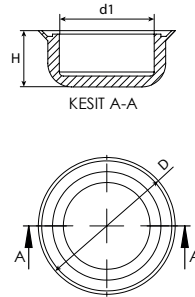

Malzeme / Material :POLIETILEN/POLYTHENE

MEYSELE KOD / CODE	METRİK/METRIC	AA	ÖLÇÜ (mm) / DIMENSIYONİ (mm)			
			D	d1	L	H
103001	M8	-	20,00	14,00	-	8,50

PROTECTIVE COVER
DİŞ ÜSTÜ KAPAK

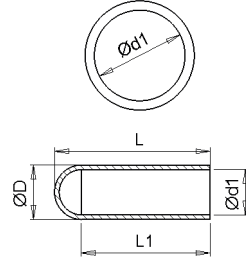

Malzeme / Material : POLIETİLEN/POLYTHENE

MEYSELE KOD / CODE	GAZ / GAS	AA	ÖLÇÜ (mm) / DIMENSIONI (mm)			
			D	d1	H	h1
101980	G3/8		19,00	16,00	21,00	20,00

PROTECTIVE PLUGS
DİŞ ÜSTÜ KAPAK

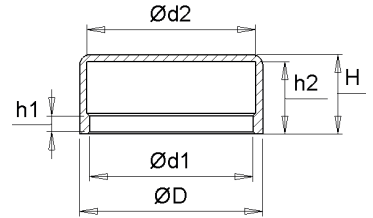

Malzeme / Material : POLIETİLEN/POLYTHENE

MEYSELE KOD / CODE	MM	D	ÖLÇÜ (mm) / DIMENSIONI (mm)				
			d1	d2	h1	h2	H
101960	22,50	25,40	22,50	23,40	2,20	10,00	11,00

PROTECTIVE COVER
DIŐ ÜSTÜ KAPAK

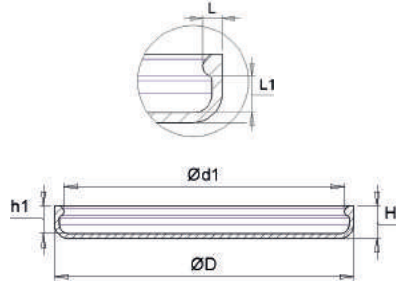

PLASTIC PLUG
PLASTIK TAPA

Malzeme / Material :POLIETILEN / POLYTHENE

MEYSELE KOD / CODE	ÖLÇÜ (mm) / DIMENSIONI (mm)						
	MM	D	d1	h1	H	L	L1
101940	121,50	129,50	121,50	12,00	14,00	4,00	7,50

PROTECTIVE PLUGS
DIŐ ÜSTÜ KULAKLI YUMUŐAK TAPA

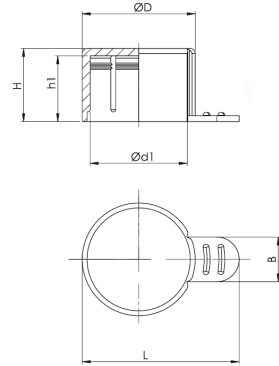

Malzeme / Material :PVC

MEYSELE KOD / CODE	METRİK/METRIC	ÖLÇÜ (mm) / DIMENSIONI (mm)				
		AA	D	d1	L	H
101701	M12x1,5	15,00	11,80	21,00	12,00	13,00
101703	M18x1,5	19,80	17,50	27,50	14,50	15,80
101702	M24x1,5	27,00	23,80	42,00	13,00	11,00

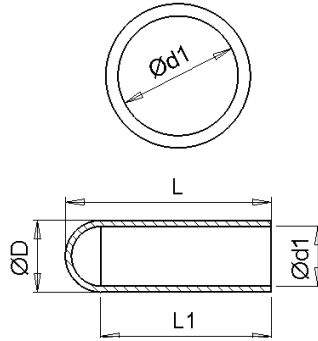

Malzeme / Material :PVC

MEYSELE KOD / CODE	METRİK/METRIC	AA	ÖLÇÜ (mm) / DIMENSIYONİ (mm)			
			d1	D	L1	L
101964	M14	-	13,70	16,50	39,00	47,00

HORN CAP BOYNUZ TAPASI

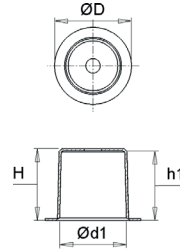

PLASTIC PLUG
PLASTIK TAPA

Malzeme / Material :POLIETILEN/POLYTHENE

MEYSELE KOD / CODE	ÖLÇÜ (mm) / DIMENSIONI (mm)					
	MM	AA	D	d1	H	h1
101400	60,00	-	87,50	60,00	65,30	63,30

HORN CAP BOYNUZ TAPASI

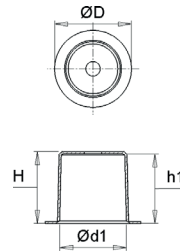
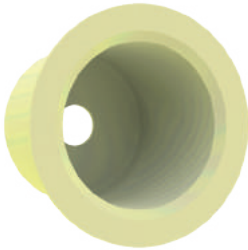

Malzeme / Material :PVC

MEYSELE KOD / CODE	ÖLÇÜ (mm) / DIMENSIONI (mm)					
	MM	AA	D	d1	H	h1
101411	60,00	-	87,50	60,00	65,30	63,30

SPECIAL PRODUCTS

ÖZEL ÜRÜNLER



HYDRAULIC ARM KUMANDA KOLU

MEYSELE
plastic protections

PLASTIC PLUG
PLASTİK TAPA

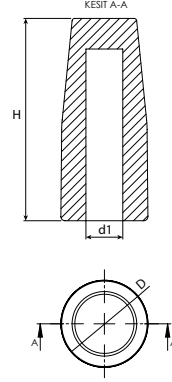

Malzeme / Material :PP

MEYSELE KOD / CODE	METRİK/METRIC	AA	ÖLÇÜ (mm) / DIMENSIONI (mm)			
			D	d1	L	H
150151	M8	-	20,50	M8	185,00	137,00
150152	M10	-	20,50	M10	185,00	137,00

HYDRAULIC ARM PLASTIC KUMANDA KOLU PLASTİĞİ

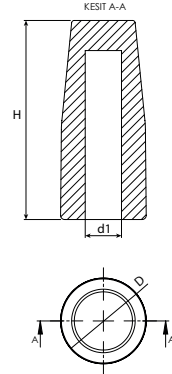

Malzeme / Material :PP

MEYSELE KOD / CODE	METRİK/METRIC	AA	ÖLÇÜ (mm) / DIMENSIONI (mm)			
			D	d1	L	H
150101	M8	-	20,50	M8	-	48,00
150102	M10	-	20,50	M10	-	48,00

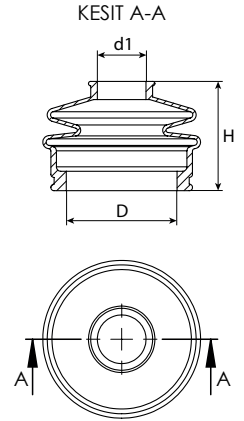

Malzeme / Material : PVC

MEYSELE KOD / CODE	BOĞUM/RING	AA	ÖLÇÜ (mm) / DIMENSIONI (mm)			
			D	d1	L	H
200251	1	-	24,00	12,00	-	26,00



KESİT A-A

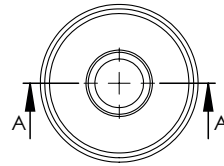
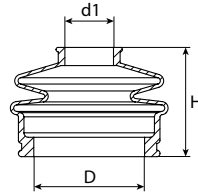

Malzeme / Material : KAUÇUK / RUBBER

MEYSELE KOD / CODE	BOĞUM/RING	AA	ÖLÇÜ (mm) / DIMENSONI (mm)			
			D	d1	L	H
200202	2	-	39,00	14,00	-	41,00
200203	1	-	35,00	11,00	-	26,00
200204	3	-	42,00	16,00	-	48,00
200205	2	-	28,50	13,00	-	28,00

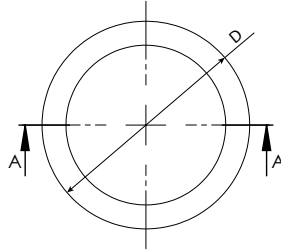
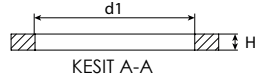

Malzeme / Material : POM

MEYSELE KOD / CODE	ÖLÇÜ (mm) / DIMENSIONI (mm)					
	GAZ / GAS	AA	D	d1	L	H
151103	G 3/8 "	-	29,00	20,00	-	1,90
151104	G 1/2 "	-	35,00	25,00	-	2,50
151106	G 3/4 "	-	43,00	30,00	-	2,50
MEYSELE KOD / CODE	ÖLÇÜ (mm) / DIMENSIONI (mm)					
MM	AA	D	d1	L	H	
151120	73,50	-	80,90	73,50	-	3,00

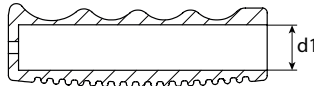
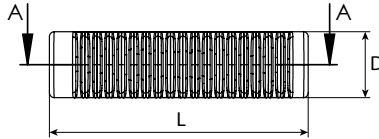

KESIT A-A

Malzeme / Material : TPE

MEYSELE KOD / CODE	ÖLÇÜ (mm) / DIMENSIONI (mm)					
	MM	AA	D	d1	L	H
150501	21,00	-	28,00	21,00	108,00	-

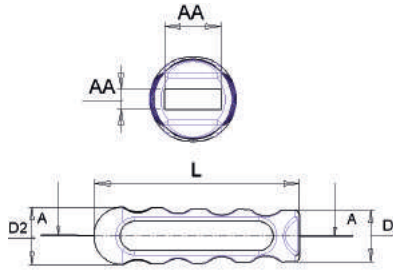

Malzeme / Material : TPE

MEYSELE KOD / CODE	ÖLÇÜ (mm) / DIMENSIONI (mm)					
	MM	AA	D	D2	L	H
150510	-	18x6,50	25,00	27,00	98,00	-

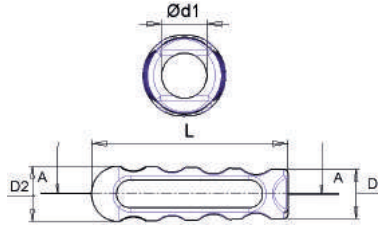

Malzeme / Material : TPE

MEYSELE KOD / CODE	ÖLÇÜ (mm) / DIMENSIONI (mm)					
	MM	AA	D	d1	L	H
150515	15,00	-	25,00	14,80	98,00	-

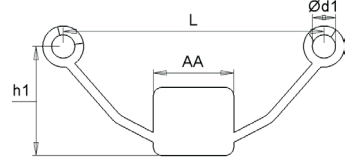

Malzeme / Material :POLIETILEN/POLYTHENE

MEYSELE KOD / CODE	ÖLÇÜ (mm) / DIMENSIONI (mm)					
	D	AA	d1	L	H	h1
101550	-	28x24	8,00	90,00	-	37,50

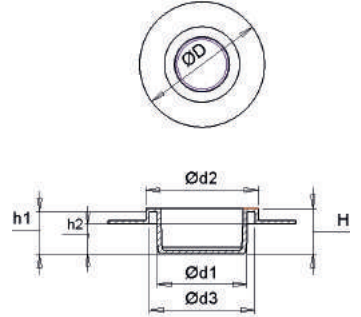

Malzeme / Material :POLIETILEN/POLYTHENE

MEYSELE KOD / CODE	ÖLÇÜ (mm) / DIMENSIONI (mm)								
	MM	D	d1	d2	d3	h1	h2	H	
151010	30,00	63,00	30,10	37,90	35,50	14,00	10,00	15,20	

SQUARE PLUG KARE TAPA

MEYSELE
plastic protections

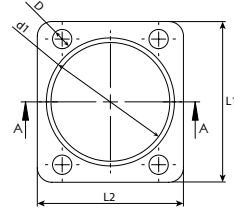
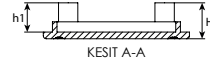

PLASTIC PLUG
PLASTİK TAPA

Malzeme / Material :POLİETİLEN/POLYTHENE

MEYSELE KOD / CODE	ÖLÇÜ (mm) / DIMENSIONI (mm)							
	MM	AA	L1	L2	d1	D	h1	H
103101	M8	42x33	55,00	50,00	43,20	6,50	12,00	10,00

SQUARE PLUG KULAKLI KARE ETİKET TAPASI

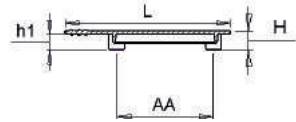
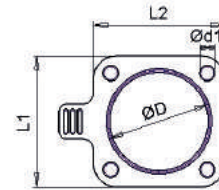

Malzeme / Material :POLİETİLEN/POLYTHENE

MEYSELE KOD / CODE	ÖLÇÜ (mm) / DIMENSIONI (mm)							
	D	AA	h1	L	L1	L2	d1	H
103120	37x37	37x50	5,50	65,00	50,00	50,00	7,00	8,50
103121	42x42	45,00	6,50	75,00	57,00	57,00	7,00	8,50
103122	50x50	57x50	6,50	79,00	66,00	64,00	7,00	8,50

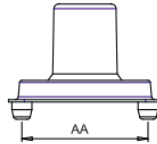
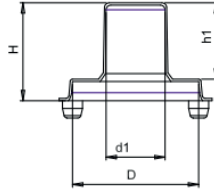

Malzeme / Material :POLİETİLEN/POLYTHENE

MEYSELE KOD / CODE	ÖLÇÜ (mm) / DIMENSIONI (mm)				
	AA	D	d1	H	h1
151101	80x80	80,00	36,00	64,00	48,00

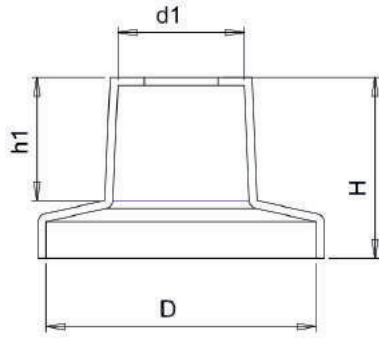

Malzeme / Material :POLIETİLEN/POLYTHENE

MEYSELE KOD / CODE	ÖLÇÜ (mm) / DIMENSIYONİ (mm)					
	DİMENSİYONİ	AA	D	d1	H	h1
150250	20,00	-	37,00	15,00	30,00	19,00

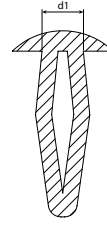

KESİT A-A

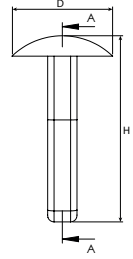

Malzeme / Material : POM

MEYSELE KOD / CODE	ÖLÇÜ (mm) / DIMENSIONI (mm)					
	MM	d2	D	d1	L	H
150801	3,50	4,20	8,00	3,50	-	14,20
150802	5,20	6,80	9,00	5,20	-	15,70

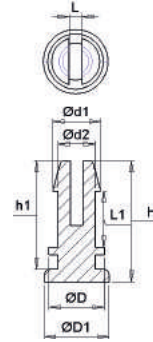

Malzeme / Material : POM

MEYSELE KOD / CODE	ÖLÇÜ (mm) / DIMENSIONI (mm)									
	MM	D1	D	d1	d2	h1	H	L1	L	
150806	2,65	3,55	3,05	2,65	2,00	6,00	6,70	3,10	0,70	

SENSOR COVER SENSÖR KAPAĞI

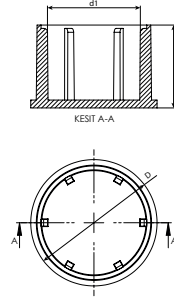

PLASTIC PLUG
PLASTİK TAPA

Malzeme / Material :POLİETİLEN/POLYTHENE

MEYSELE KOD / CODE	ÖLÇÜ (mm) / DIMENSIONI (mm)					
	MM	AA	D	d1	H	h1
150901	23,00	-	32,00	23,00	21,00	19,00

VALVE SEAL VENTİL KEÇESİ

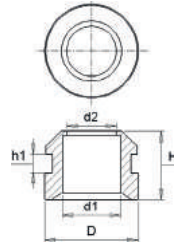
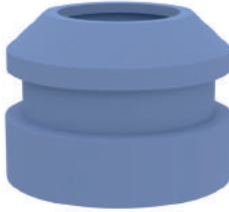

Malzeme / Material :PVC

MEYSELE KOD / CODE	ÖLÇÜ (mm) / DIMENSIONI (mm)				
	d1	d2	D	h1	H
200210	14,00	12,00	22,50	4,50	16,50

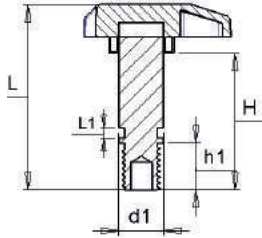

Malzeme / Material : PP

MEYSELE KOD / CODE	METRIK	ÖLÇÜ (mm) / DIMENSIONI (mm)				
		d1	h1	H	L1	L
150550	M12	13,90	14,50	43,00	3,00	60,00

PALLET WEDGE
PALET TAKOZU



KESİT A-A

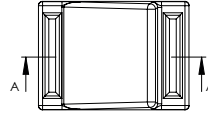
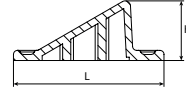

Malzeme / Material : TPE

MEYSELE KOD / CODE	MODEL	ÖLÇÜ (mm) / DIMENSIONİ (mm)				
		AA	D	d1	L	H
150601	PALET TAKOZU	-	-	-	56x40	22,00

BRACKET PLUGS
BRACKET TAPASI

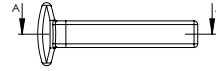

KESİT A-A

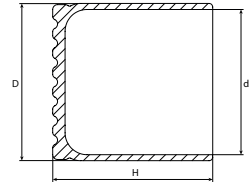

Malzeme / Material : PVC

MEYSELE KOD / CODE	MODEL	ÖLÇÜ (mm) / DIMENSIONİ (mm)				
		AA	D	d1	d2	H
103301	BRACKET TAPASI	-	63,00	58,80	6,00	63,00

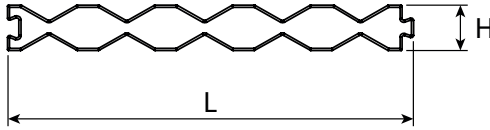
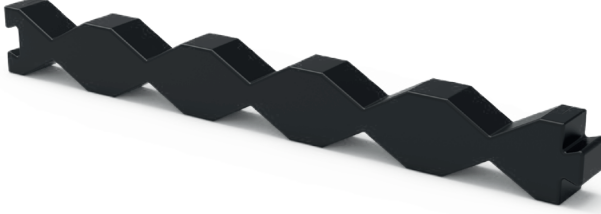

Malzeme / Material : PP

MEYSELE KOD / CODE	MODEL	AA	ÖLÇÜ (mm) / DIMENSIONI (mm)			L	H
150701	V YATAĞI	-	-	-	-	580,00	65,00

SHAFT FIXING LİFT V YATAĞI

MEYSELE
plastic protections

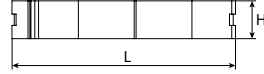
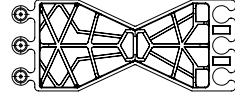

PLASTIC PLUG
PLASTİK TAPA

Malzeme / Material : PP

MEYSELE KOD / CODE	MODEL	ÖLÇÜ (mm) / DIMENSIONI (mm)				
		AA	D	d1	L	H
150702	V YATAĞI	-	-	-	-	-

SHAFT FIXING LİFT V YATAĞI

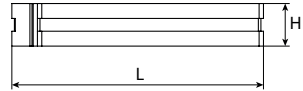
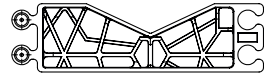

Malzeme / Material : PP

MEYSELE KOD / CODE	MODEL	ÖLÇÜ (mm) / DIMENSIONI (mm)				
		AA	D	d1	L	H
150703	V YATAĞI	-	-	-	-	-

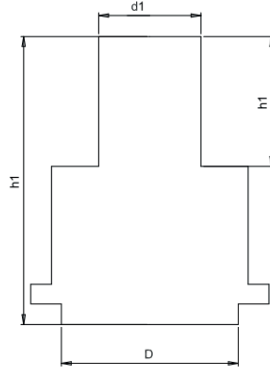
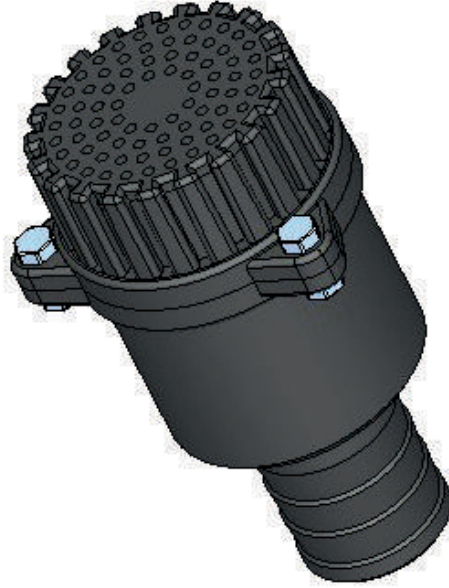

Malzeme / Material : N6 GFR30

MEYSELE KOD / CODE	DIMENSIYONİ	ÖLÇÜ (mm) / DIMENSIYONİ (mm)				
		AA	D	d1	H	h1
200250	2"	-	90,00	52,00	193,00	66,00

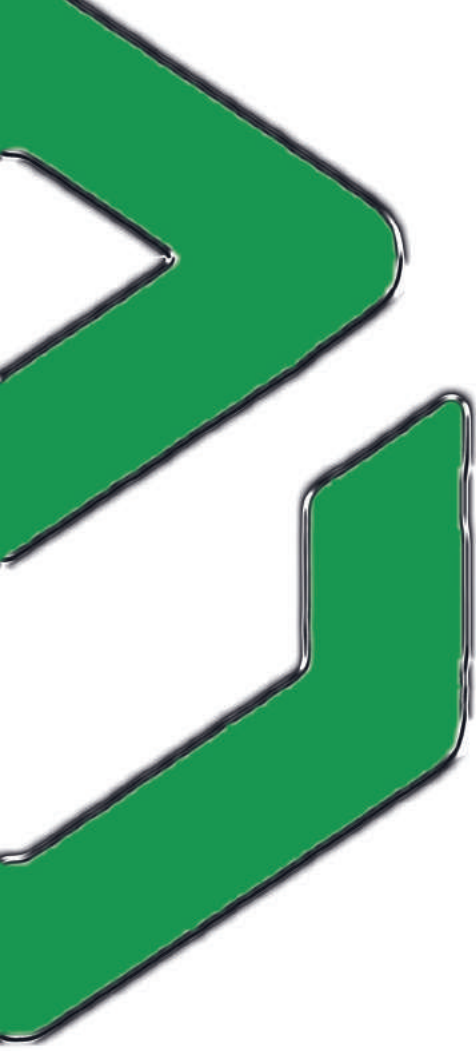

MEYSELE
plastic protections

Horozluhan Mahallesi
Karatay Sanayi Ek Blokları
Güvenilir Sokak.
No : 66-68-70
SELÇUKLU - KONYA
Tel: + 90 332 249 4126
Whatsapp: 0 532 784 2760
Skype : Meysele
E-posta:
meysele@meysele.com.tr

www.meysele.com.tr